

# MODEL: 4ETSF6030

ALL ACCESSORIES OPTIONAL

**Remodeler**

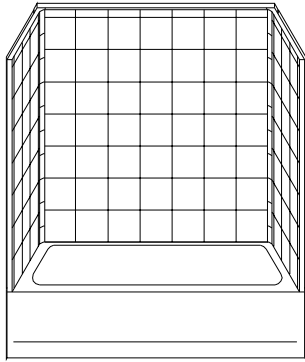

PERSPECTIVE VIEW - N.T.S.  
MODEL SHOWN HERE AS:  
RIGHT HAND

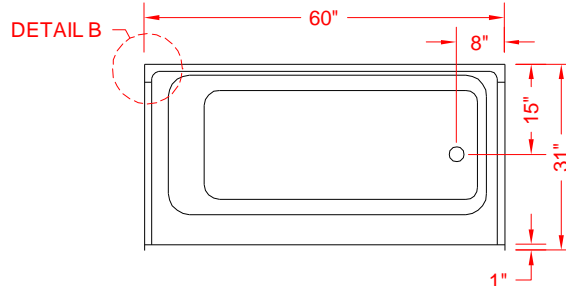

TOP VIEW - SCALE  $\frac{3}{8}'' = 1'-0''$

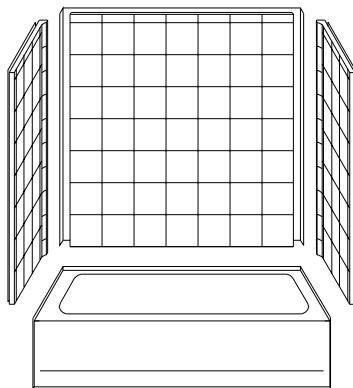
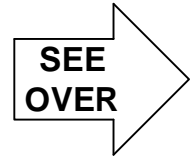

ASSEMBLY VIEW - N.T.S.

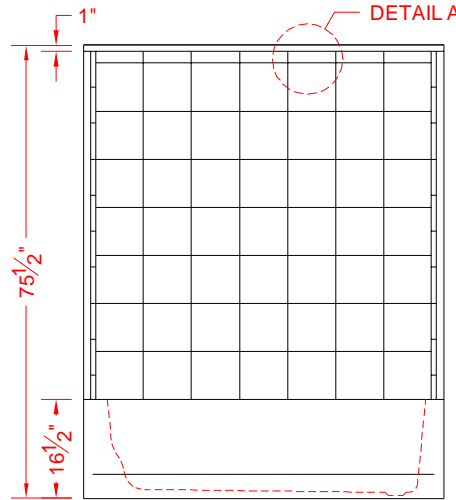

FRONT ELEVATION - SCALE:  $\frac{3}{8}'' = 1'-0''$

### Features:

- Four piece gelcoat/fiberglass tub/shower module
- "Eight Inch Tile" wall finish, white (standard)
- Integral full wood backing for strength and unlimited accessory placement
- The authentic look of ceramic tile without the grout
- Flat upper back wall to avoid interference with windows, grab bars, etc.

\* - SEE BACK FOR DETAIL SECTIONS

### PRODUCT SPECIFICATIONS:

- Four-piece tub/shower module shall be constructed of gelcoat/fiberglass with full integral plywood backing in the walls
- Door opening: 57-1/2" x 57-3/4"
- Rough-In: Stud opening +1/4" -0" Nominal Dimensions.
- C.S.I. FORMAT SPECIFICATION TEXT AVAILABLE

### PRODUCT INFORMATION:

- Accessories: Factory installed, unless prone to damage during installation/shipping. Polished chrome/satin stainless standard, others available.
- Colors: White as standard, others to match any major fixture manufacturer, also available with sprayable solid surface in many colors

### ACCESSORIES:

- INSTALLED BY OTHERS:
- Grab bars
  - Seat, folding
  - Mixing valve, pressure balanced, lever handle, preplumbed tree to supply elbow
  - Curtain and rod
  - Soap dish

### CODES:

- Designed and manufactured in compliance with the following standards and codes:
- A.N.S.I. Z1241.2 Standards for plastic Bathtubs and Showers
  - I.P.C. International Plumbing Code
  - U.P.C. Uniform Plumbing Code

### NOTICE OF LIMITATION:



BEST BATH SYSTEMS INC.  
www.best-bath.com 1-800-727-9907

*We reserve the right to make revisions without notice in the design of fixtures or in packaging unless this right has specifically been waived at the time the order is accepted.*

# Remodeler

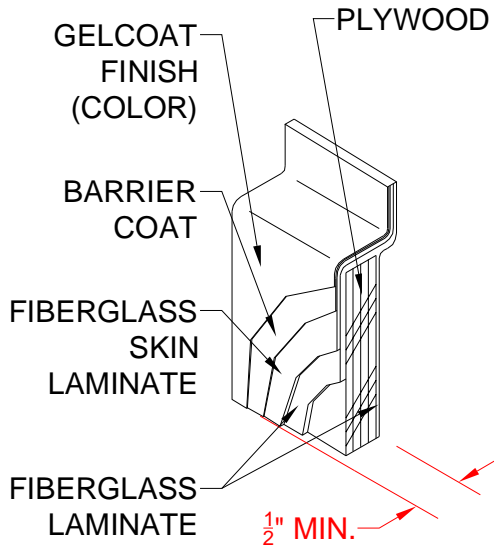

DETAIL A - SCALE N.T.S.  
WALL SECTION DETAIL

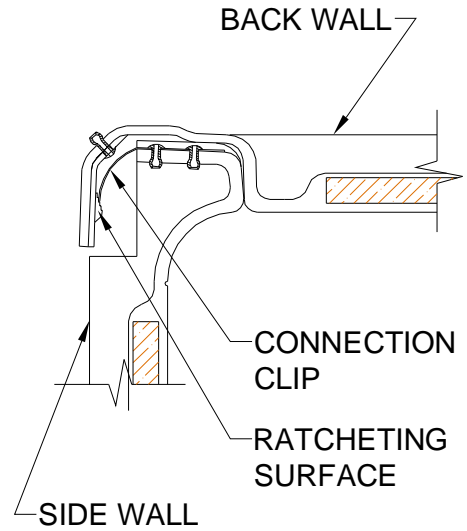

DETAIL B - SCALE N.T.S.  
WALL JOINT DETAIL

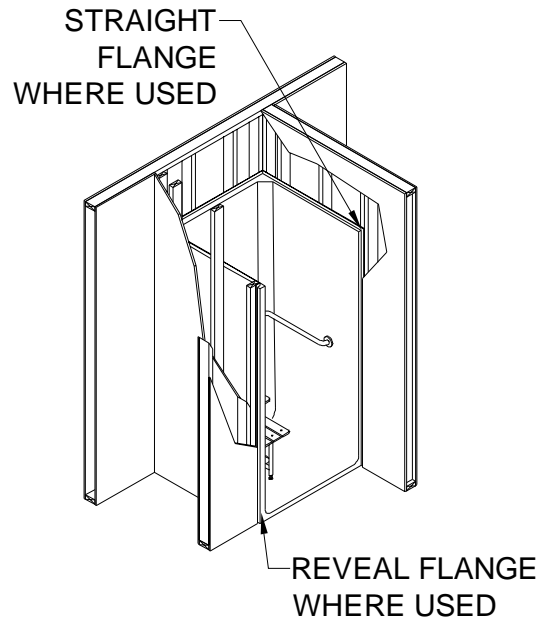

DETAIL C - SCALE N.T.S.  
TYPICAL FRAMING DETAIL