

MODEL: CSS4836B5B*

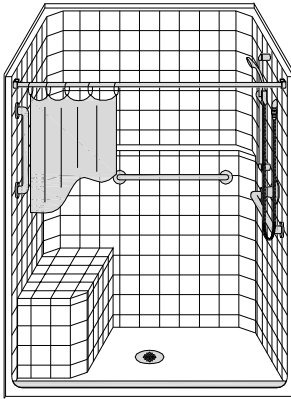

ALL ACCESSORIES OPTIONAL



**PERSPECTIVE VIEW - N.T.S.
MODEL SHOWN HERE AS:
RIGHT PLUMBING**

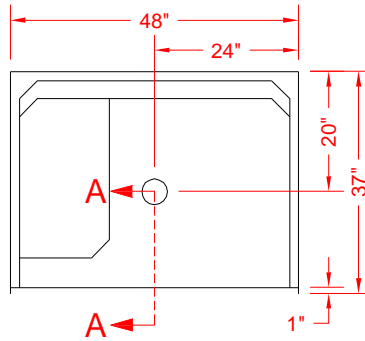

TOP VIEW - SCALE $\frac{3}{8}'' = 1'-0''$

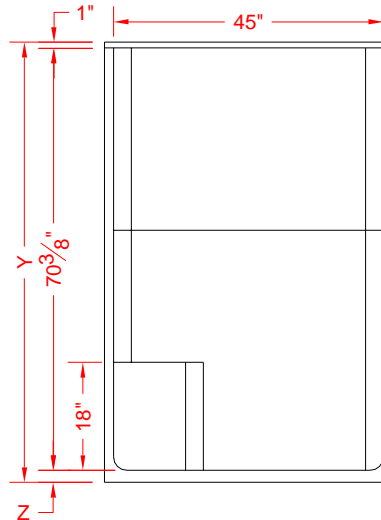

FRONT ELEVATION - SCALE: $\frac{3}{8}'' = 1'-0''$

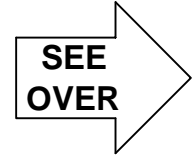

Features:

- Molded, one piece gelcoat/fiberglass shower module
- Available in various threshold heights
- "Classic Tile" wall finish, white (standard)
- Integral full wood backing for strength and unlimited accessory placement
- On all threshold, heights 1-1/2" or taller, no mud set is required
- On all threshold, heights 1-1/4" or shorter, no mud set is required, but an epoxy adhesive kit is supplied

*OTHER THRESHOLD HEIGHTS AVAILABLE UPON REQUEST

	UNIT HEIGHT	THRESHOLD HEIGHT
MODEL #	Y	Z*
CSS4836B5B	72"	5/8" MIN.
CSS4836B2B	73-3/8"	2" MAX.

* - SEE BACK FOR DETAIL SECTIONS

PRODUCT SPECIFICATIONS:

- One piece shower module shall be constructed of gelcoat/fiberglass with full integral plywood backing
- Rough-In: Stud opening +1/4" -0" Nominal Dimensions.

C.S.I. FORMAT SPECIFICATION TEXT AVAILABLE

PRODUCT INFORMATION:

- Accessories: Factory installed, unless prone to damage during installation/shipping. Polished chrome/satin stainless standard, others available.
- Colors: White as standard, others to match any major fixture manufacturer, also available with sprayable solid surface in many colors
- Custom curb heights, other than shown, are available (between min. and max.)

ACCESSORIES:

INSTALLED AT FACTORY:

- Grab bar
- Mixing valve, pressure balanced, lever handle, preplumbed tree to supply elbow
- Vacuum breaker
- Soap dish

INSTALLED BY OTHERS:

- Curtain and rod
- Collapsible Rubber Water Retainer
- Semi-permanent Threshold Adaptor
- Caulkless drain

CODES:

- Designed and manufactured in compliance with the following standards and codes:
- A.N.S.I. Z124.2 Standards for Plastic Showers
 - I.P.C. International Plumbing Code
 - U.P.C. Uniform Plumbing Code

NOTICE OF LIMITATION:



DIV. OF FIBERGLASS SYSTEMS INC.
www.best-bath.com 1-800-727-9907

We reserve the right to make revisions without notice in the design of fixtures or in packaging unless this right has specifically been waived at the time the order is accepted.

CSS4836B5B

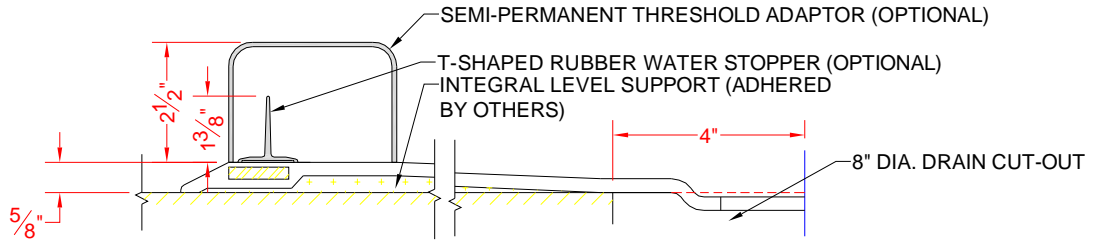

SECTION A-A - SCALE: 3" = 1'-0"

CSS4836B2B

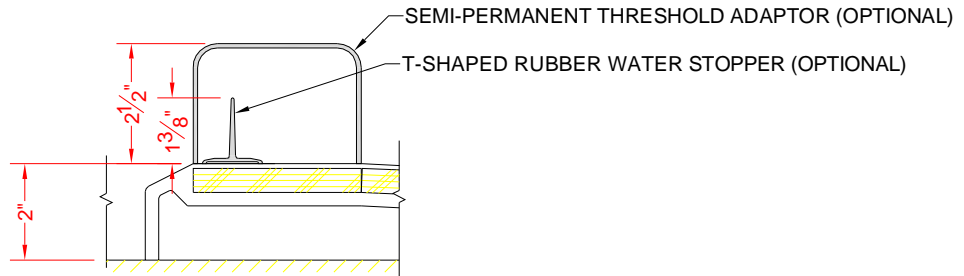

SECTION A-A - SCALE: 3" = 1'-0"

****OTHER THRESHOLD HEIGHTS AVAILABLE UPON REQUEST****

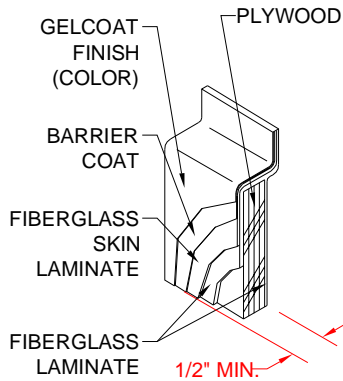

DETAIL B - SCALE: 3" = 1'-0"
WALL SECTION DETAIL

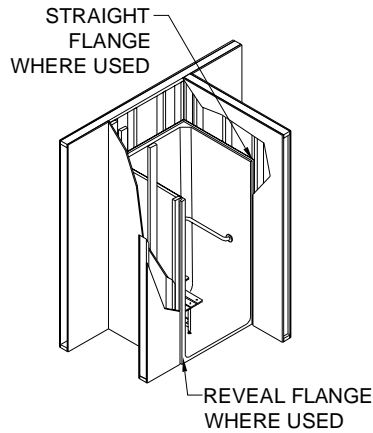

DETAIL C - SCALE: NTS
TYPICAL FRAMING